

PROXIMITY INDUCTIVE 18BY

Model: LJ18A3-8-Z/BY



Specifications:

Product Name	Inductive Proximity Switch
Model	LJ18A3-8-Z/BY
Theory	Inductive Sensor
Wire Type	3 Wire Type (Brown, Blue, Black)
Switch Appearance Type	Cylinder Type
Output Type	NO (Normal Open)
Detection Distance	8mm +/- 10%
Electrical Voltage	6-36V DC
Set Distance	0~7mm
Output Current (max)	200mA
Detect objects	Iron
Standard Detection Object	Iron 30x30x1mm
Response Frequency	DC 0.5kHz , AC 25Hz
Column Sensor Diameter	18mm
Thread Diameter	18mm
External Dimensions	M18x68
Cable Length	1.1m
External Material	Plastic, Alloy

Dimension	M18
Detection Distance	8mm
Dimensional Drawing	

Model	DC Type	NPN	NO	LJ18A3-8-Z/BX
			NC	LJ18A3-8-Z/AX
			NO+NC	LJ18A3-8-Z/CX
		PNP	NO	LJ18A3-8-Z/BY
			NC	LJ18A3-8-Z/AY
			NO+NC	LJ18A3-8-Z/CY
	Two-wire	NO	LJ18A3-8-Z/EX	
		NC	LJ18A3-8-Z/DX	
	AC Type	Two-wire	NO	LJ18A3-8-J/EZ
			NC	LJ18A3-8-J/DZ
		mree-wire	NO+NC	LJ18A3-8-J/EDZ

Installation:

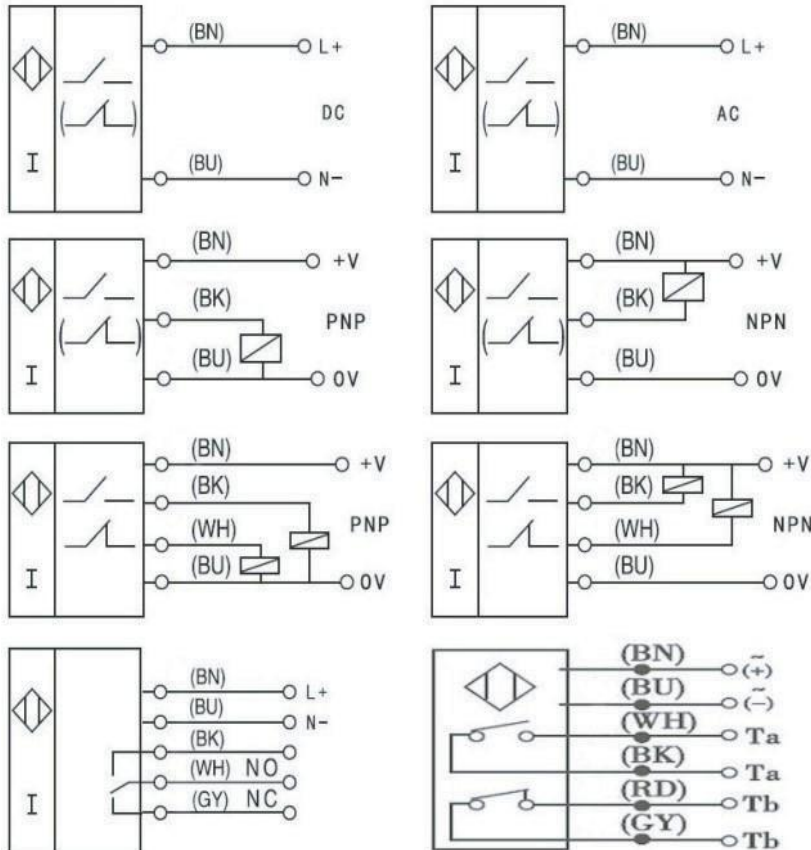

Applications legend:

1、Various position detection in machining centre

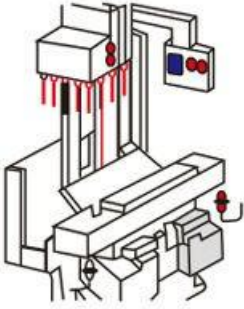

Cylindrical type proximity switch

2、Action sequence cam detection

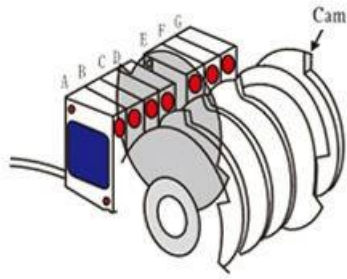

Flat type proximity switch

3、Pulser

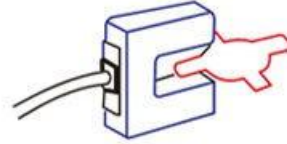

Slot type proximity switch

4、Bottle cap detection

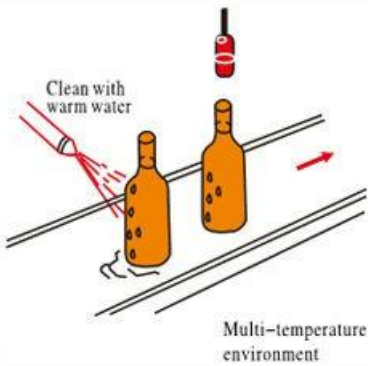

Water-proof type proximity switch

5、Grinder stop detection

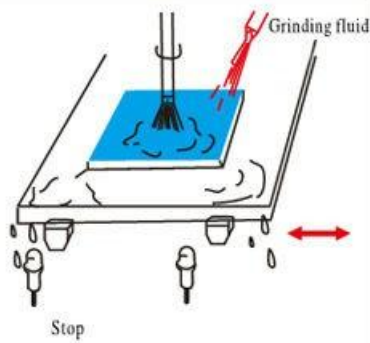

Water-proof type proximity switch

6、Detect whether there is milk inside the paper packet

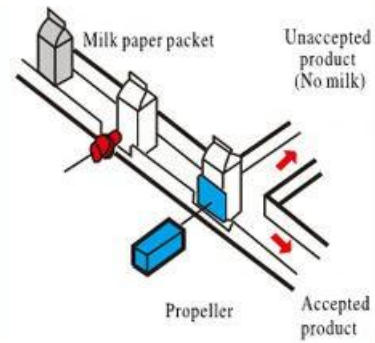

Capacitive type proximity switch